

Installer instructions.

For DC Blue Digital model.

Remove this section on completion of the installation and leave the balance of the pages in the cover with the end user.

Revision May 2009

FEATURES

- Emergency overload sensing system.
- Load sensing system automatically compensates for minor variances in nominal door load.
- Soft start/soft stop motor run. Smoother operation.
- Digital limit positioning.
- All settings retained in cases of power interruptions.
- Selectable auto-close function.
- Adjustable auto-close time up to 100sec.
- Manual override for when hand operation is necessary.
- Safety beam input for safer operation.
- Suitable for both Tip-up and Sectional overhead type doors.
- Magnetic Hall Effect Sensor system for proven reliability.
- High torque, low rpm motor mounted in a unique C-chassis for quieter operation.
- Courtesy light activates for 3min whenever the door runs.

Technical Specifications

- Max. opening height – 3m
- Max door size – 10m²
- Primary power supply – 220Vac +/- 10% 50Hz
- Travel speed – 7.2m/min @ 10kgF when battery is charged.
- Light bulb – 24V 10W bayonet mount.
- Standby power consumption - < 5W
- Fixed magnet 24Vdc motor
- Chain drive
- Max. run time – 99sec
- 4 selectable load sensing levels
- Motor fuse – fast blow 8A glass 25mm x 5mm located in circuit on board.
- Primary supply fuse – fast blow 3A glass 25mm x 5mm located inline primary wiring.

Remove these installer pages and issue the balance to the end user as a user guide.

Safety Obligations.
Read and understand before commencing installation. Failure to follow these Obligations can cause irreparable damage or harm to the system and or person.

Prior to installation:

- The door must be balanced correctly to the tensioning system.
 - When operated by hand the door should be free of hindrance and easily moved.
 - When left at any position in its travel, the door should neither rise nor fall. If the door does rise or fall, re-balance the tensioning system. (Tensioning should only be carried out by a qualified and experienced person)
- The door material must be sound and whole. Ensure the areas where the operator attaches have been re-enforced. The door hardware must be in good serviceable condition.
- Ensure the wall above the door is sound and strong enough to allow proper fixing of the operator. If necessary use through bolts and or cross brace plate to spread the load. (Typically on cinder brick or hollow walls)
- Do not use false fascias for mounting.
- The DC Blue Digital is designed for weatherproof applications only. Free of moisture and dust. Install in completely walled and roofed garages only.
- Ensure the area of installation is not subject to explosive hazards. There should be no inflammable gasses or fumes as these can present a serious safety hazard.
- The DC Blue Digital is designed to be used in low traffic applications only. Do not install on doors used for multi parking garages like office parks or apartment blocks with single entrance.
- The DC Blue Digital is supplied with a sealed 15A safety plug on lead for use in an electrical code of practice approved plug point. Do not extend, modify or replace the plug lead unless duly qualified as an electrician. Before installing the unit, ensure the mains supply is switched off.
- It is the responsibility of the installer to ascertain that the designated persons (including children) intended to use the system, do not suffer reduced physical sensory or mental capabilities, or lack of experience and knowledge, unless they have been given supervision or instruction concerning the use of the system by a person responsible for their safety.
- The drive may not be installed on a door incorporating a wicket door. Unless the drive is disabled by the release of the wicket door.

Installation:

- Remove all cables, latches or catches not necessary for automation.
- Ensure the working area is clear of obstructions and obstacles.
- No modification should be made to the DC Blue Digital operator.

Cont.....

Remove these installer pages and issue the balance to the end user as a user guide.

Safety Obligations continued....

- Use of any installation procedure alternate to what is laid out in this documentation can be hazardous and will not be the responsibility of ET Systems.
- Install the door sticker depicting the safety reverse test and keeping door area clear. This sticker should be fixed to the inside surface of the door or near any permanent door control switches such as a wall console if installed.
- The emergency release cord must be installed where it is no higher than 1.8m from the floor level. The label explaining the manual release operation must be fixed to the, or adjacent to the actuating component of the release mechanism.
- Any additional fixed door control switches such as wall consoles, if installed, must be at a height of at least 1,5m, within clear sight of the door and away from any moving components of the system.
- Do not substitute any component of DC Blue Digital with any other manufacturer's part. ET Systems accepts no responsibility for the safety and correct operation of the automation system if any of these points are ignored.

After Installation:

- It is the responsibility of the installer to ensure the user:
 - Is proficient in the use of the manual emergency release mechanism.
 - Is issued with the documentation accompanying this product.
 - Understands that the door may not be operated out of clear sight.
 - Ensures that children are kept clear of the door area and that children do not play with the remote transmitters.
 - Is instructed not to attempt to repair or adjust the automation system.
 - Is proficient in testing the unit's safety sensing system by means of placing a 40mm high object (wooden block) below the door in the closed position. On contact with the object the unit must reverse the door away and back to the open position.

Assembling the drawbar to the motor-head

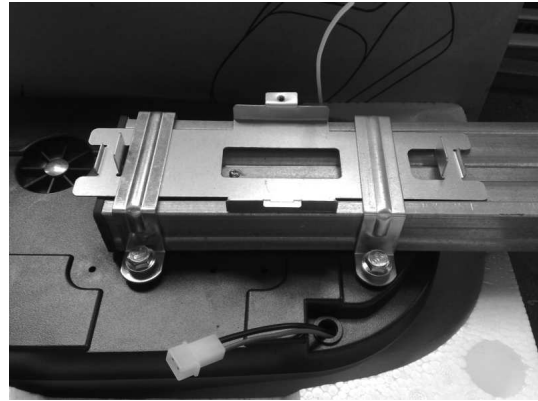

1. While aligning the splined shaft and socket, gently press the motor head and drawbar together. Use the packaging to rest the motor head on while doing this so as not to damage the motor head cover.
2. Swing the drawbar so that it lies evenly between the fastening points as above.
3. Place the battery mounting base plate on top of the drawbar as shown above in the pictures. (For ease of handling only install the battery once unit is hanging in final position. This is shown on page 7 of this manual)
4. Fasten the mounting straps down using the 4 x 12mm M8 machine bolts supplied. Take care not to over tighten, as this will strip the brass inserts out of their moldings.

Mounting hanging angle bracket to drawbar

Attach the hanging angle bracket as shown here, using the 3rd strap provided. Ensure there is 50-100mm between the motor-head and strap.

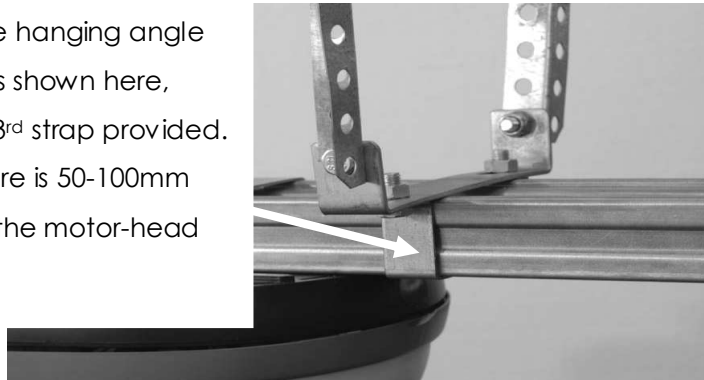

Hanging Angle Configurations. (Always use a cross-brace as shown)

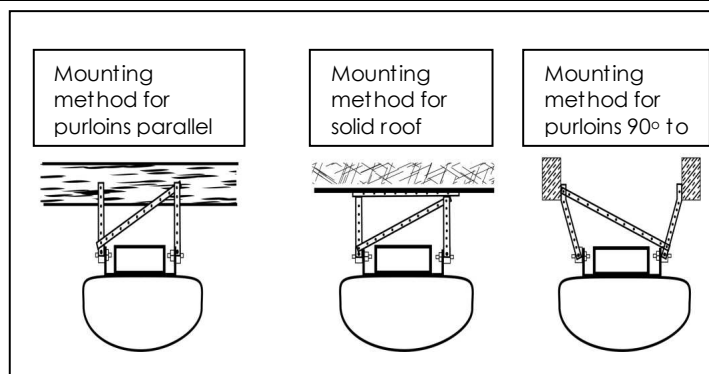

Remove these installer pages and issue the balance to the end user as a user guide.

Trackless tip up type door automation

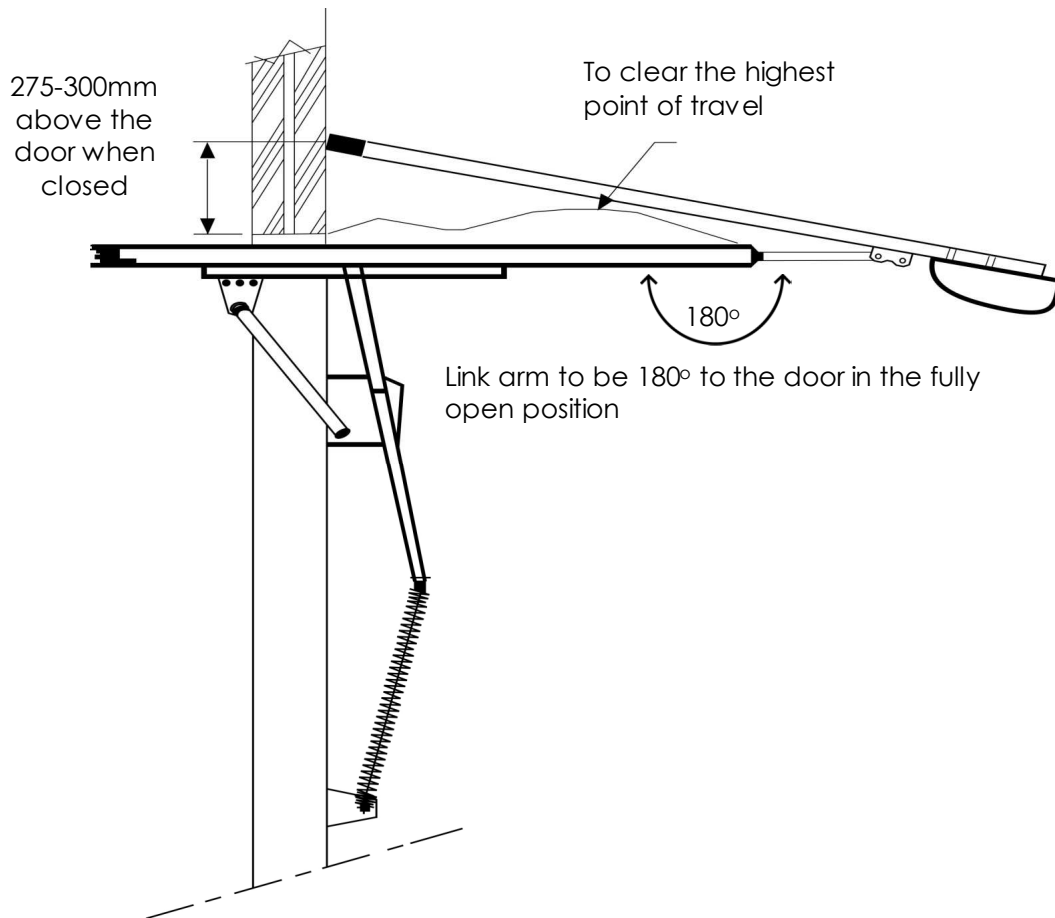

Failure to adhere to these measurements can result in intermittent operation and even damage to the door and DC Blue Digital unit. Do not use the measurements for worm drive motors as doing so will shorten continued trouble free use of the unit. Only use the straight link-arm for this type of installation.

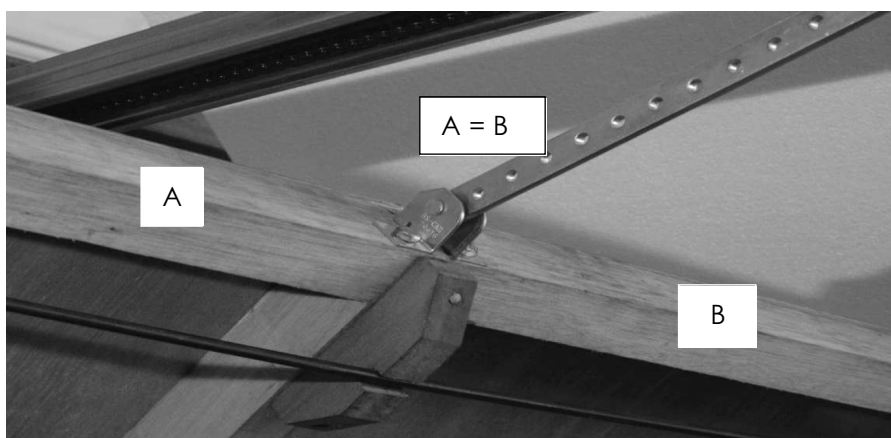

In the case of a tip up type door automation, the open end of the door bracket must face the floor when the door is fully open.

Remove these installer pages and issue the balance to the end user as a user guide.

Overhead sectional door type automation

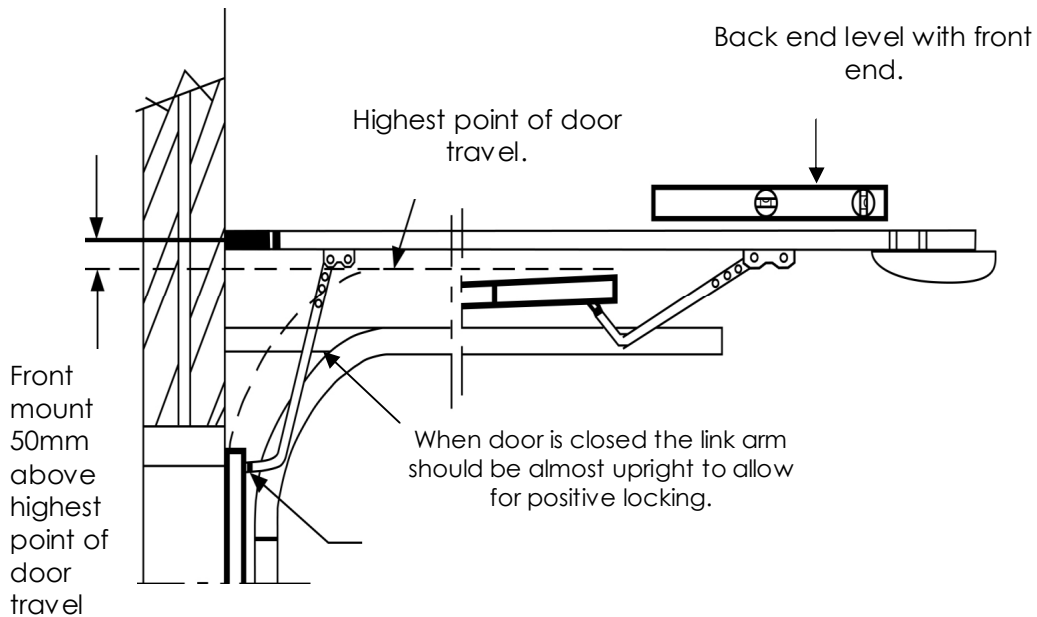

Failure to adhere to these measurements can result in intermittent operation and even damage to the door and/or DC Blue Digital unit.

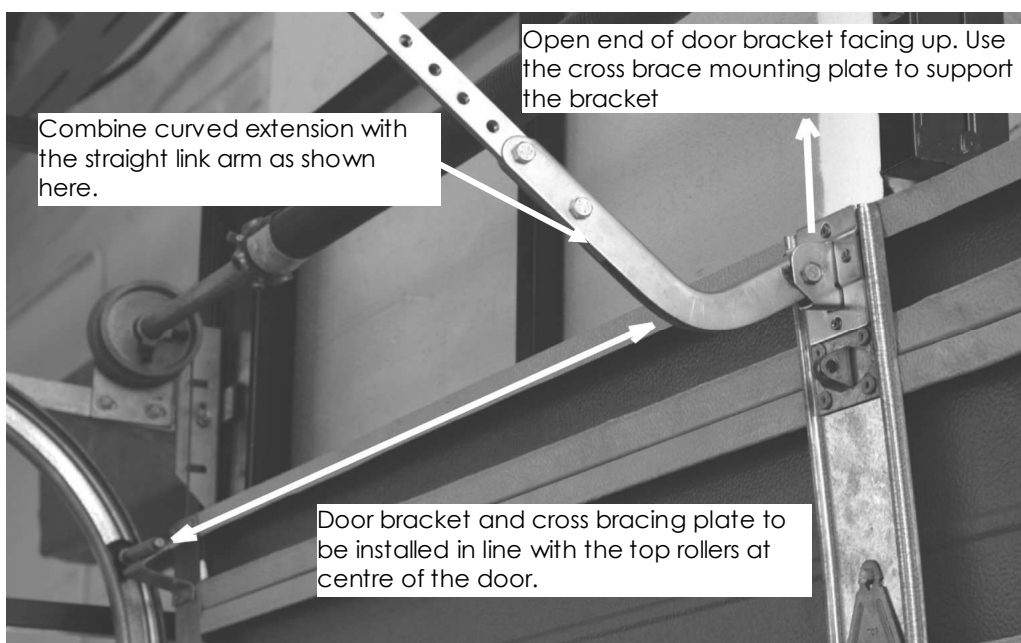

Remove these installer pages and issue the balance to the end user as a user guide.

How to install the battery

The battery bracket kit consists of:

- 1 x base plate
- 1 x holding strap
- 1 x machine screw

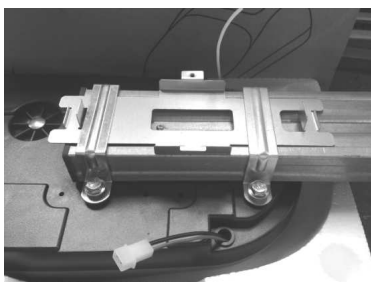
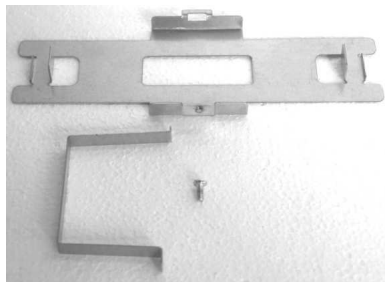

The battery mounting base plate should already be installed beneath the motor head mounting straps. (See "Assembling the drawbar to the motor-head" on page 4)

Mount and fasten the battery into the bracket kit as shown alongside here.

Be sure to position the battery right side up as seen here! Even though the battery is sealed it should not be installed upside down!

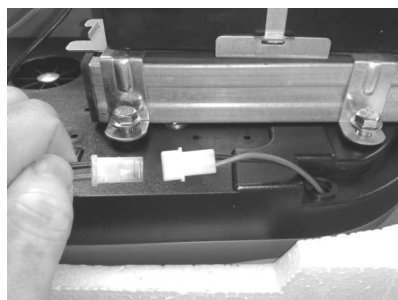
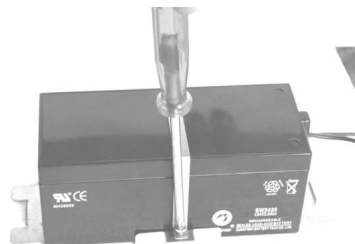

Connect the battery lead from the battery to the battery lead from the control card by pressing the male and female plugs together. Make sure to match the polarity. Red to Red and Black to Black.

Do not force the two together. They are molded to assemble in one direction only.

Important note about the battery back-up!
The Battery and charger need to be inspected on a regular basis.

The battery capacity is 3.5 A/hour at 24Vdc when fully charged.

In the case of a power failure the DC Blue Digital will draw all power from the battery. This includes the standby current required by the control card.

The battery reserve will last approximately 18 - 24hrs without running the door (and with no auxiliaries connected) thereafter the door may not run correctly.

The running time available on the battery will be dependent on how heavy the door resistance is and how long the door run time is per full cycle. The heavier the door resistance or the longer the run time, the more drain on the battery reserve each cycle.

The battery recharge time is approximately 10hrs – 12hrs to full charge on resumption of mains power supply.

NB! Extended power failures will be detrimental to the lifespan of the battery. To prevent irreversible damage to the battery re-apply power immediately you become aware of the power interruption.

Electronic wiring and programming

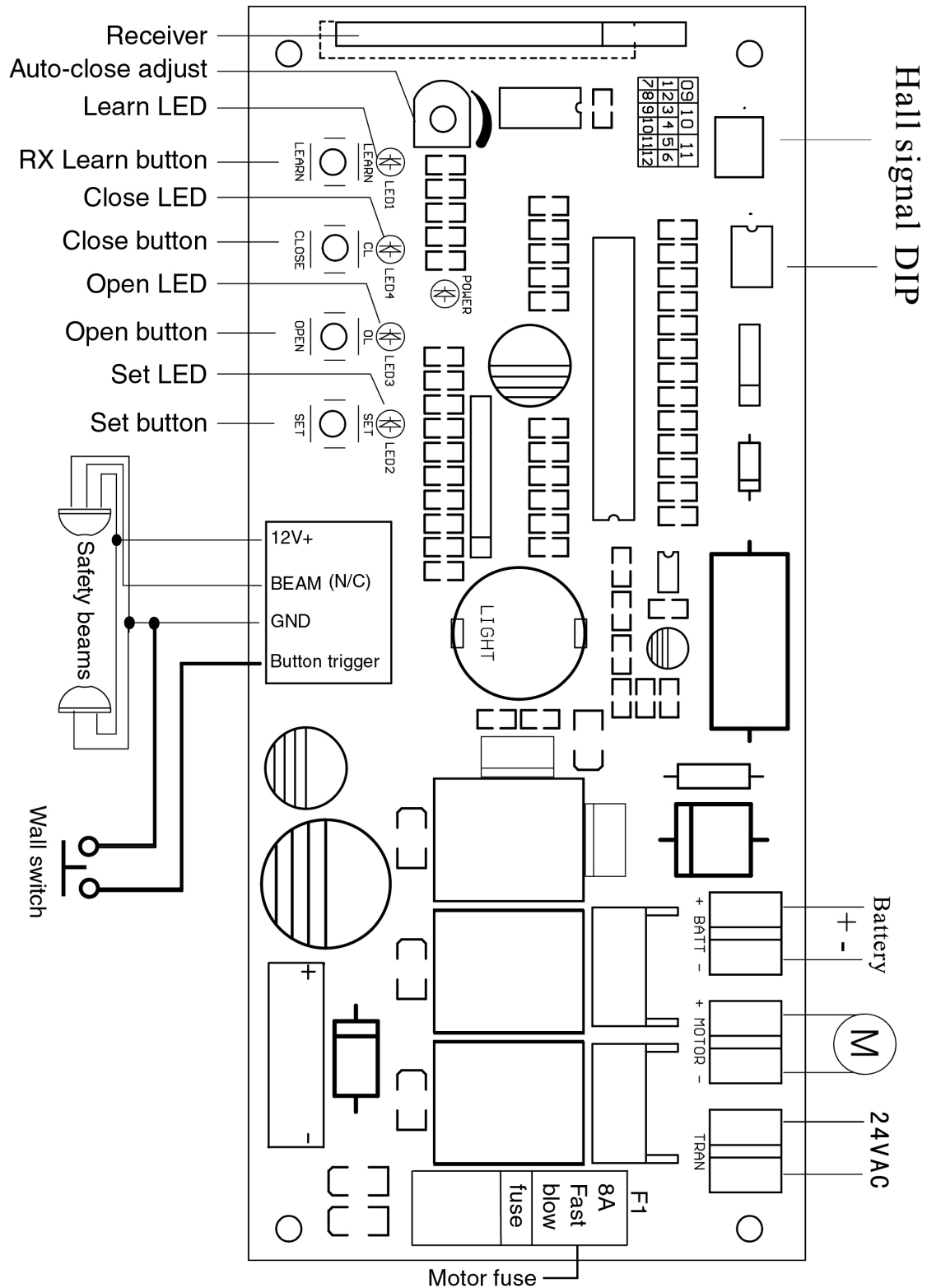

Remove these installer pages and issue the balance to the end user as a user guide.

Setting the travel limits

1. Press and hold **SET** button +/- 3 sec.
 - Both **SET** LED and **OPEN** LED will illuminate.
2. Release **SET** button.
3. Press and hold **OPEN** button.
 - Door will open.
2. Release **OPEN** button at required open limit.
 - Door will stop.
3. (Fine tune position using **OPEN** and **CLOSE** buttons if necessary)
4. Press and release **SET** button to save open limit.
 - **OPEN** LED will extinguish and **CLOSE** LED will illuminate.
5. Press and hold **CLOSE** button.
 - Door will close.
6. Release **CLOSE** button at required closed limit.
 - Door will stop.
7. (Fine tune position using **OPEN** and **CLOSE** buttons if necessary)
8. Press and release **SET** button to save closed limit.
 - Door will confirm limit travel by automatically running to open position and returning to closed position.

This completes the limit setup.

NB! If the unit initiates the safety overload routine at any time during the limit setup:

1. Power down,
2. Adjust the overload sensing as below,
3. Power up,
4. Begin limit setup routine from the beginning again.

If the unit is allowed to stop in the open position on obstruction sensing and not the limit switch, mechanical damage can occur. I.e. fiberglass doors being ripped.

Setting the overload Sensing.

The ratings below indicate the amount of resistive load allowed before the safety routine will activate.

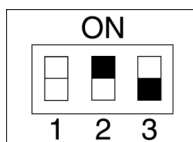

Light
Resistance

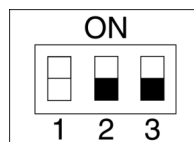

Light-medium
Resistance

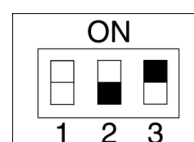

Medium-heavy
Resistance

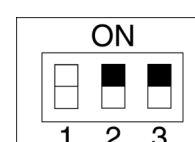

Heavy
Resistance

Remove these installer pages and issue the balance to the end user as a user guide.

**Selecting and adjusting Auto-close
(ONLY USE IN CONJUNCTION WITH A SAFETY DEVICE SUCH AS INFRA-RED BEAMS)**

To activate the auto-close feature switch Dip switch 1 on.

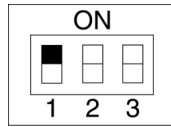

The time the door remains open can be adjusted from 1 sec to 100 sec by turning the auto-close pot clockwise.

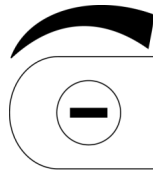

PROGRAMMING OF THE ONBOARD RECEIVER (15user memory)

Master erase/defaulting. (It is recommended that this be done on installation).

1. Power down
2. Press and hold **LEARN** button,
3. While holding **LEARN** button, power up again.
4. **LEARN** LED begins flashing on and off,
5. **LEARN** LED extinguishes,
6. **LEARN** LED illuminates permanently.
7. Release **LEARN** button and remove power,
8. Return power without holding **LEARN** button.

All previously programmed remote transmitters are now erased.

Programming a remote transmitter into memory. (Hold the remote transmitters +/- 500mm away from the receiver antenna when programming).

1. Begin by selecting a button on the remote transmitter,
2. Start transmitting (FIRST) by pressing and holding the remote transmitter button required,
3. Press the **LEARN** button,
4. **LEARN** LED will flash confirmation.

LED Flashes	Meaning
x 1	Successful - first user programmed. Master remote transmitter.
x 2	Successful - There is still memory available.
Multiple rapid flashes	Unsuccessful - Memory is full
No flashes	Unsuccessful - Either a non - ETBLUE remote transmitter is being used or there is another remote transmitter active on 433.92MHz and it is blocking the signal.

Remove these installer pages and issue the balance to the end user as a user guide.

Erasing an incorrectly programmed remote transmitter. (For example if the neighbour's remote transmitter was accidentally memorized while programming).

1. Begin by pressing and holding the master remote transmitter (User 1 remote transmitter) button until **LEARN** LED illuminates.
2. Release the **Master remote transmitter** button.
3. Within 10 sec. press and hold the incorrectly programmed remote transmitter button.
4. **LEARN** LED will begin flashing confirmation of successful erase.
5. Release the now erased remote transmitter button.

WARRANTY: All goods manufactured by G&C Electronics cc T/A ET Systems carry a 12 month factory warranty from date of invoice. All goods are warranted to be free of faulty components and manufacturing defects. Faulty goods will be repaired or replaced at the sole discretion of ET Systems free of charge. This warranty is subject to the goods being returned to the premises of ET Systems. The carriage of goods is for the customers account. This warranty is only valid if the correct installation and application of goods, as laid out in the applicable documentation accompanying said goods, is adhered to. All warranty claims must be accompanied by the original invoice. All claims made by the end user must be directed to their respective service provider/installer.

The following items are not included in the warranty.

1. The light globe
2. The batteries (Limited 6 month warranty)
3. The motor brushes
4. Acceptable wear and tear.

The following conditions will disqualify this product from the warranty as laid out above.

These conditions are non-negotiable.

Any single DC Blue DIGITAL garage door operator used to automate more than one door at one time.

Any DC Blue DIGITAL garage door operator used outdoors, including carports.

Any DC Blue DIGITAL domestic garage door operator used in excessive traffic applications for example an apartment-block parking garage.

Any unauthorized non-manufacturer modifications to the product or components thereof.

When contacting any of our support centers please have a record of any unusual activity. This will assist in the accurate diagnostic of the fault and assist us in maintaining our high expectancy of support for our products. You may be asked to take readings with a multi-meter. Please have one handy. If you are not proficient in the use of a multi-meter please contact a service provider in your area. Your nearest ET Systems branch will have contact details of preferred service providers in your area.